

Attached to
User Manual

Explanation for Each Function

Front Panel

Rear Panel

IR Remote Controller



Version : FM-BB
HDD Used : SATA HDD
Edition : 20 Aug 2008

1. Front Panel

The buttons on both the front panel of the DVR and IR Remote Controller have the same function, but may be different each other in shape.

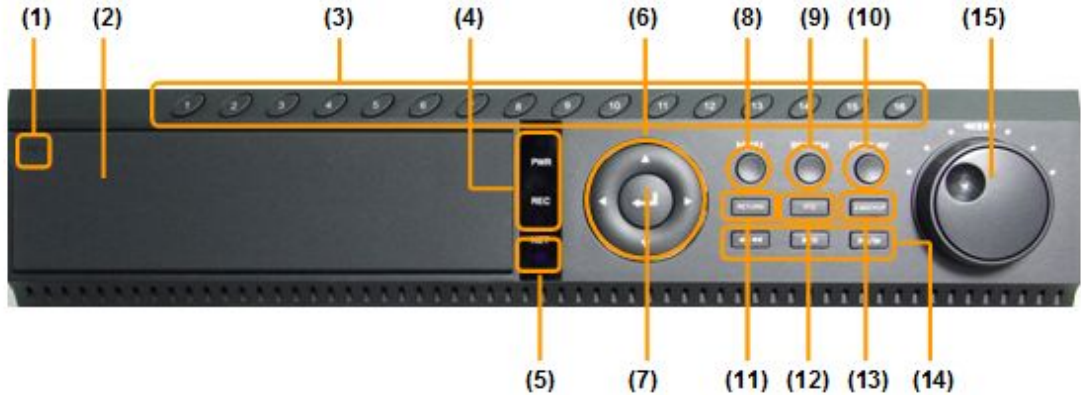

No.	Buttons	Functions
1	DVD Burner Opener	DVD Burner Cover opening
2	DVD Burner Cover	Backup the recorded image by internal DVD burner (Option)
3	Numeric Button	Select the desired channel or input password
4	LED Indicator	Indicates system status. Power, Record and Network status
5	IR Sensor Window	Sensor Input for IR remote controller
6	Direction Button	Move to the desired menu position
7	Enter Button	Select value or setting
8	Menu Button	Open system menu
9	Search Button	Go to search mode
10	Screen Mode/Display Button	Select screen display mode or rotation mode
11	Return Button	Cancel setup or return to previous mode
12	PTZ/Focus Button	Control camera PTZ and focus
13	E-Backup Button	Emergency backup
14	Playback Control Button	Fast Rewind & One-frame backward, Play/Pause by toggle, Fast Forward & One-frame forward
15	Jog/Shuttle Knob	Image playback in various speed or frame by frame

Note You can find two functional buttons and USB Port when DVD Burner cover is opened.

Power Button : System startup or shutdown

Instant Record Button

Enables to start emergency recording during live monitoring mode.

USB Port (Ver 2.0) : Mouse operation or image backup



Note **Emergency Recording (Instant Recording)**

DVR will instantly start recording for all channels at CIF resolution up to maximum fps rate in total when user presses the "REC" button. All channels, regardless of recording mode & recording on/off, are to be recorded.

Note **Emergency Backup (Quick Backup)**

In playback mode, user can press "E-BACKUP" button to set backup "start" time. Once "Quick backup starts" message is shown, and then press the same "E-BACKUP" button again to set backup "end" time. Then backup menu window will be popped up to save the selected video images.

1.1.1. DVD Burner (Option)

To install DVD Burner to backup the recorded image. Refer to "Setting > Backup" for detailed explanation.

1.1.2. IR Sensor Window (Remote Controller Receiver)

To receive input signal from the IR remote controller

1.1.3. USB Port (Version 2.0)

- 1) To backup recorded images by using USB storage device (USB Memory Stick or USB HDD).
- 2) System software upgrade
- 3) Mouse connection for system operation

1.1.4. Screen Mode/Display Button

Screen display mode can be selected.

1.1.5. PTZ Button

- 1) Once pressed, DVR is changed to Pan & Tilt mode.
User can control Pan & Tilt operation by using Direction Button
- 2) If pressed again, DVR is changed to Zoom & Focus mode
User can control Zoom & Focus operation by using Direction Button

1.1.6. Search Button

To search the recorded image by date and time.

Refer to "Operation > Search recording Image" for detailed image searching method.

1.1.7. Menu Button

To set the system configuration according to user requirement.

1.1.8. Direction Button

- 1) Live Display & Playback Mode
User can change channel no by using Left & Right arrow button.
User can change display mode by using Up & Down arrow button
- 2) Menu Mode (when system menu is displayed)
To move to desired menu position.
- 3) Pan & Tilt Mode (once PTZ Button is pressed)
To move connected camera to desired direction.
- 4) Zoom & Focus Mode (when PTZ Button is pressed again)
User can control Zoom-In & Out by using Up & Down arrow button.
User can control Focus-In & Out by using Left & Right arrow button

1.1.9. Return Button

To cancel the setting or return to previous mode.

1.1.10. Enter Button

- 1) To select value or setting
- 2) Quick backup function during playback. Refer to User Manual section 3.5

1.1.11. Shuttle

Jog/Shuttle dial is used to playback the recorded images. The inner dial is called Jog and the outer dial is called Shuttle. The Jog/Shuttle dial has two kinds of functions. The Shuttle is used to speed up the playback speed of images by clockwise or anti-clockwise. Playback speed is indicated as x2, x4, x8, x16, x32 on the lower end of the screen.

1.1.12. Jog

The Jog is used to find the recorded image frame by frame. Turn the Jog dial clockwise or anti-clockwise to see the image frame by frame during pause state.

2. Rear Panel

[4 Ch DVR – 200/240 fps Recording Model]

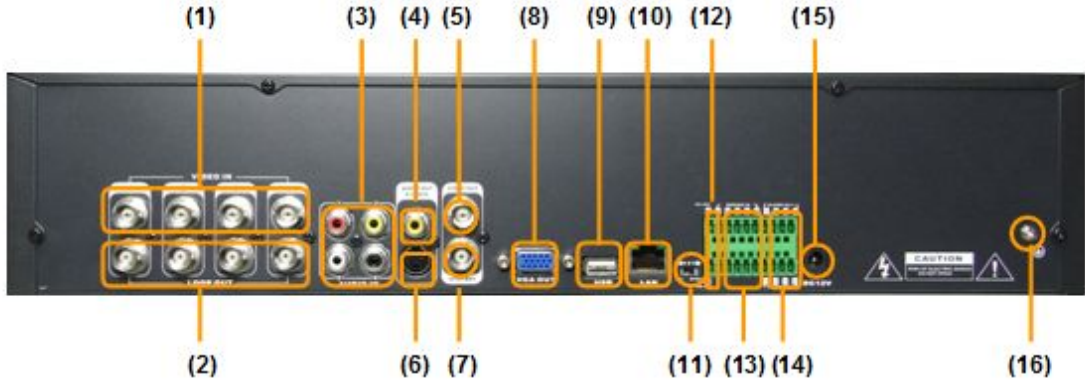

[8 Ch DVR – 200/240 fps Recording Model]

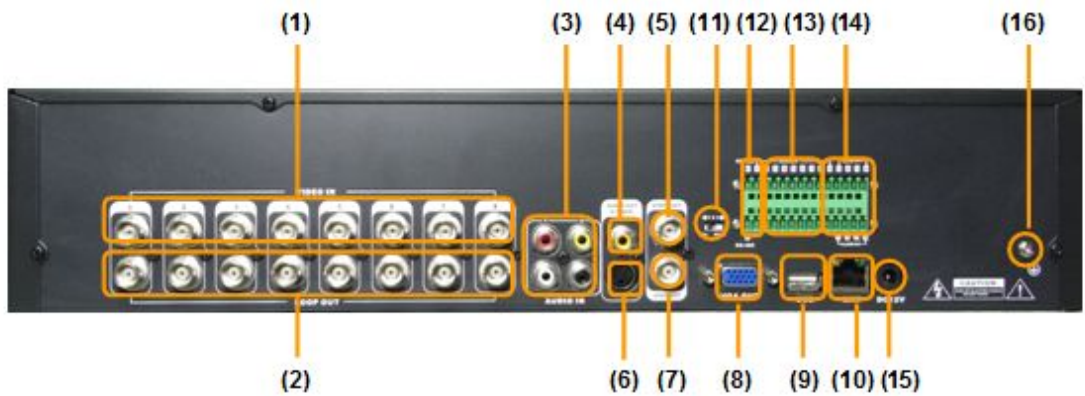

[16 Ch DVR – 200/240 fps Recording Model]

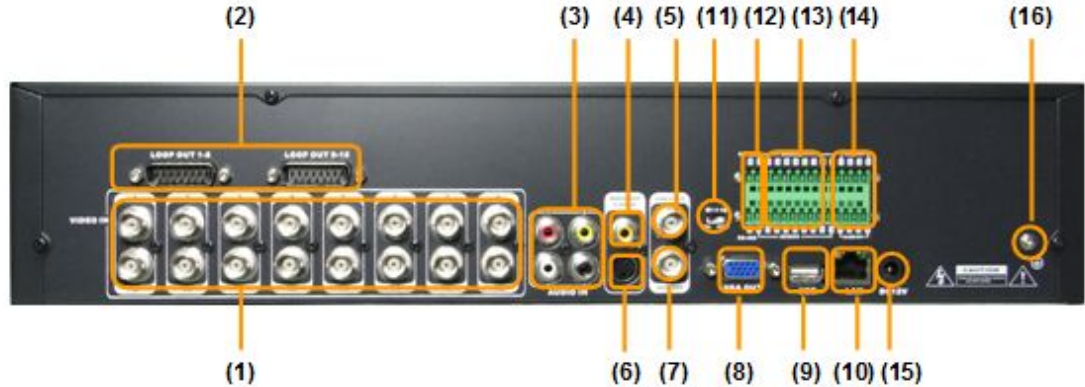

No.	Name	Description
1	Video-In	Connect camera. (Supports NTSC/PAL)

2	Video Loop-Out	Loop-out of camera images
3	Audio-In	Connect the audio input device (with amplifier)
4	Audio-Out	Connect the audio output device (with amplifier)
5	Video-Out	Connect the CCTV monitor
6	S-Video	Connect to S-Video terminal
7	Spot-Out	Connect the spot monitor
8	VGA-Out	Connect the P/C(VGA) monitor
9	USB Port	USB port (Ver 2.0) for mouse operation or Image backup
10	LAN Port	10/100 Ethernet connection terminal
11	NTSC/PAL Selection	Select the video signal type
12	RS-485 Port	Connect the PTZ camera and/or external keyboard controller
13	Sensor Input	Connect the external sensor
14	Alarm Output	Connect the external alarm device
15	Power Input	Power cable connection (Default : 12 V, 5~8A)
16	Grounding Terminal	For device grounding

[16 Ch DVR – 400/480 fps Recording Model]

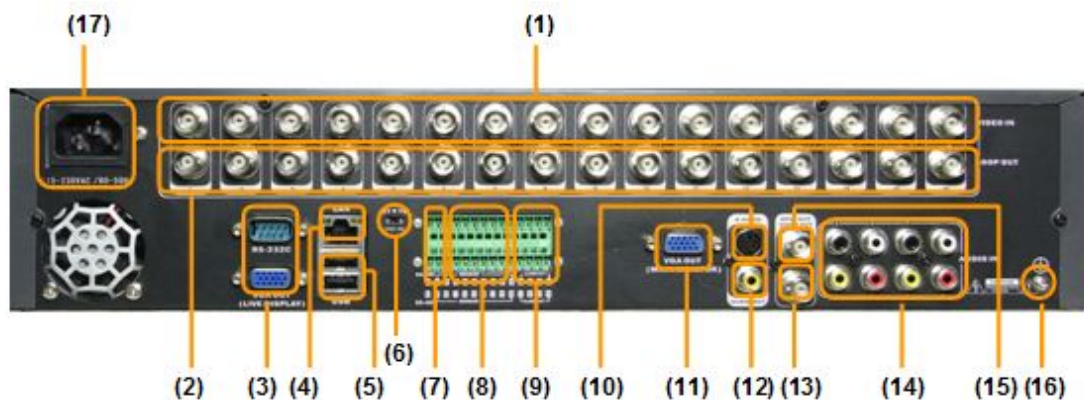

No.	Name	Description
1	Video-In	Connect camera. (Supports NTSC/PAL)
2	Video Loop-Out	Loop-out of camera images
3	Debugging Terminal	For system debugging and health checking
4	LAN Port	10/100 Ethernet connection terminal
5	USB Port	USB port (Ver 2.0) for mouse operation or Image backup
6	NTSC/PAL Selection	Select the video signal type
7	RS-485 Port	Connect the PTZ camera and/or external keyboard controller
8	Sensor Input	Connect the external sensor
9	Alarm Output	Connect the external alarm device
10	S-Video	Connect to S-Video terminal
11	VGA-Out	Connect the P/C(VGA) monitor
12	Audio-Out	Connect the audio output device (with amplifier)
13	Video-Out	Connect the CCTV monitor
14	Audio-In	Connect the audio input device (with amplifier)
15	Spot-Out	Connect the spot monitor
16	Grounding Terminal	For device grounding
17	Power Input	Power cable connection (A/C 100~220V, 50~60 Hz)

2.1.1. Video-In

To connect the camera input to the corresponding channel marked on rear panel.

Note Camera Input voltage level is $1V_p \pm 10\%$.

2.1.2. Loop-Out

To use the camera input to other device.

Without additional video distributor, camera image can be provided to other device.

2.1.3. Video-Out

To connect the CCTV monitor.

2.1.4. Spot-Out

The spot monitor can be used to display input images in automatic switching mode.

2.1.5. Audio-Out

To connect audio output device

Note Use of audio output device with an amplifier is recommended

2.1.6. S-Video

One additional main monitor can be installed by using the S-Video output.

2.1.7. VGA-Out

To connect the P/C monitor.

2.1.8. NTSC / PAL Selection

Turn off the power of DVR and select the NTSC/PAL switch correctly. Then turn on the power again.

2.1.9. Audio-In

To connect audio input device.

2.1.10. USB Port (Version 2.0)

- 1) To backup recorded images by using USB storage device (USB Memory Stick or USB HDD).
- 2) System software upgrade
- 3) Mouse connection for system operation

2.1.11. LAN Port

To connect RJ-45 jack of LAN cable. Consult network administrator for proper network configuration.

2.1.12. Power Input

Before connecting the power cord to the system, check if the power is in accordance with the system specification.

2.1.13. Grounding Terminal

It is recommended for user to make grounding to protect the system against external electrical surge.

2.1.14. Terminal Block

- 1) Connect sensors (dry contact type) with each ground (GND) line to "G" pin.
- 2) Connect various alarm devices controlled by relay output.
- 3) Connect RS-485 cable for the control of PTZ camera and/or external keyboard controller

Note Support both N/O (Normal Open) and N/C (Normal Close) types of sensor. If connected sensor is not functioning, ensure wiring is correct. The connection method may differ according to the type of P/T/Z controller. Enquire to your vendor for guidance.

Note [4 Ch DVR]

1 2 3 4 5 6 7 8 9 10

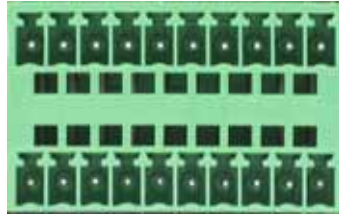

11 12 13 14 15 16 17 18 19 20

No.	Sensor
2	Sensor 1
3	Sensor 2
4	Sensor 3
5	Sensor 4
6	Sensor Ground (1~4)
12	Sensor 5
13	Sensor 6
14	Sensor 7
15	Sensor 8
16	Sensor Ground (5~8)

No.	Alarm
7	Alarm 1 (+)
8	Alarm 2 (+)
9	Alarm 3 (+)
10	Alarm 4 (+)
17	Alarm 1 (-)
18	Alarm 2 (-)
19	Alarm 3 (-)
20	Alarm 4 (-)

No.	PTZ
1	RS 485 D+
11	RS 485 D-

4 sensor-inputs for 4 Ch DVR (Pin # 12~16 : Disabled)

[8 & 16 Ch Model]

1 2 3 4 5 6 7 8 9 10 11 12 13 14

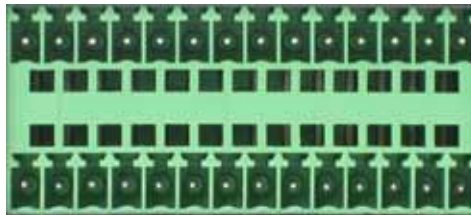

15 16 17 18 19 20 21 22 23 24 25 26 27 28

No.	Sensor
2	Sensor 1
3	Sensor 2
4	Sensor 3
5	Sensor 4
6	Sensor 5
7	Sensor 6
8	Sensor 7
9	Sensor 8
10	Sensor Ground (1~8)
16	Sensor 9
17	Sensor 10
18	Sensor 11
19	Sensor 12
20	Sensor 13
21	Sensor 14
22	Sensor 15
23	Sensor 16
24	Sensor Ground (9~16)

No.	Alarm
11	Alarm 1 (+)
12	Alarm 2 (+)
13	Alarm 3 (+)
14	Alarm 4 (+)
25	Alarm 1 (-)
26	Alarm 2 (-)
27	Alarm 3 (-)
28	Alarm 4 (-)

No.	PTZ
1	RS 485 D+
15	RS 485 D-

8 sensor-inputs for 8 Ch DVR (Pin # 16~24 : Disabled)

3. IR Remote Controller

The function buttons of the IR Remote Controller are as below.

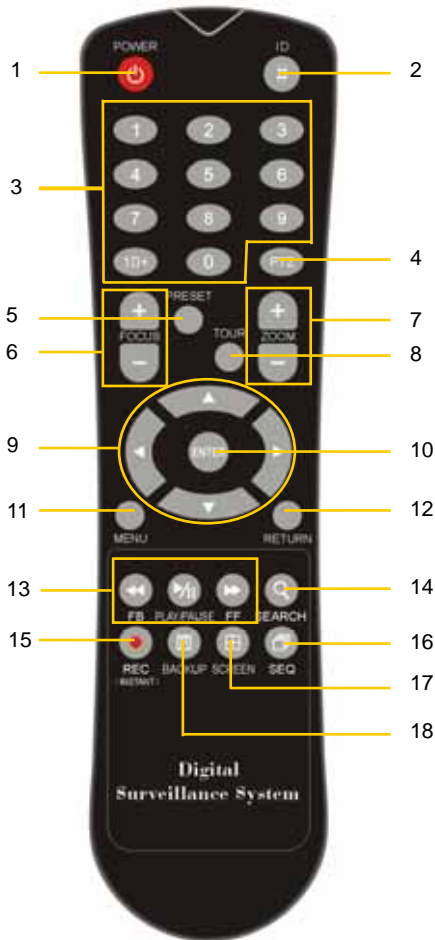

No.	Functions
1	Power Button
2	ID Selection Button
3	Numeric Button
4	PTZ Button
5	Preset Button on PTZ Mode
6	Focus Button on PTZ Mode
7	Zoom (In & out) Button on PTZ Mode
8	Preset Tour Button on PTZ Mode
9	Direction Button (Left/Right/Up/Down)
10	Enter (Selection) Button
11	Menu Button
12	Return Button
13	Playback Button on Search Mode (Fast Backward/Playback/Stop/Fast Forward)
14	Search Button
15	Instant (Emergency) Recording Button
16	Auto-Sequence Button on Live Display Mode
17	Screen Mode Button
18	Backup Button

Note To use the IR Remote Controller, set the initial ID to be same as the ID in the DVR in the menu of ; SYSTEM > SYSTEM INFO > REMOTE ID. (Default ID # for DVR and IR Remote Controller is "0") All DVR(s) have same default ID when it is out from the factory. Therefore, when the default value is used, one IR Remote Controller can control several DVR(s) at once. To prevent this, it is recommended to set different ID between DVR and IR Remote Controller.

Procedure **How to setup the ID in IR Remote Controller**

- 1) Keep pressing ID selection button marked as "#" for about 5 seconds.
- 2) Set the ID number by pressing numeric button on IR Remote Controller.
 - ID number is available from 000 up to 255.
 - You have to press numeric button as three-digit number format.
 - For example, press "000" for 0, "023" for 23, "234" for 234.